



Micro Commercial Components
 21201 Itasca Street Chatsworth
 CA 91311
 Phone: (818) 701-4933
 Fax: (818) 701-4939

MUR105 THRU MUR1100

**1 Amp Super Fast
 Recovery Rectifier
 50 to 1000 Volts**

Features

- High Surge Capability
- Low Forward Voltage Drop
- High Current Capability
- Super Fast Switching Speed For High Efficiency

Maximum Ratings

- Operating Temperature: -50°C to +150°C
- Storage Temperature: -50°C to +150°C

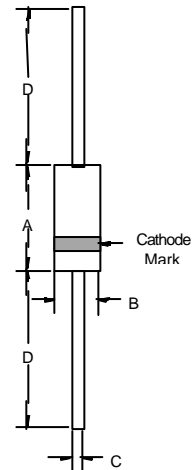
MCC Part Number	Maximum Recurrent Peak Reverse Voltage	Maximum RMS Voltage	Maximum DC Blocking Voltage
MUR105	50V	35V	50V
MUR110	100V	70V	100V
MUR115	150V	105V	150V
MUR120	200V	140V	200V
MUR140	400V	280V	400V
MUR160	600V	420V	600V
MUR180	800V	560V	800V
MUR1100	1000V	700V	1000V

Electrical Characteristics @ 25°C Unless Otherwise Specified

Average Forward Current	$I_{F(AV)}$	1 A	$T_A = 55^\circ\text{C}$
Peak Forward Surge Current	I_{FSM}	35A	8.3ms, half sine
Maximum Instantaneous Forward Voltage MUR105-115 MUR120-160 MUR180-1100	V_F	.975V 1.35V 1.75V	$I_{FM} = 1.0A;$ $T_A = 25^\circ\text{C}$
Maximum DC Reverse Current At Rated DC Blocking Voltage	I_R	5 μ A 50 μ A	$T_A = 25^\circ\text{C}$ $T_A = 150^\circ\text{C}$
Maximum Reverse Recovery Time MUR105-120 MUR140-160 MUR180-1100	T_{rr}	45ns 60ns 75ns	$I_F=0.5A, I_R=1.0A,$ $I_r=0.25A$
Typical Junction Capacitance	C_J	20pF	Measured at 1.0MHz, $V_R=4.0V$

*Pulse Test: Pulse Width 300 μ sec, Duty Cycle 1%

DO-41

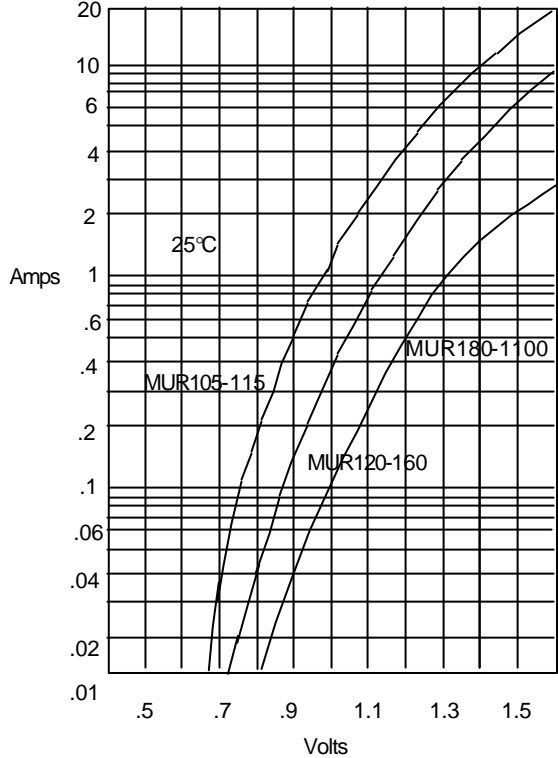


DIM	DIMENSIONS				NOTE
	INCHES		MM		
A	.166	.205	4.10	5.20	
B	.080	.107	2.00	2.70	
C	.028	.034	.70	.90	
D	1.000	---	25.40	---	

MUR105 thru MUR1100

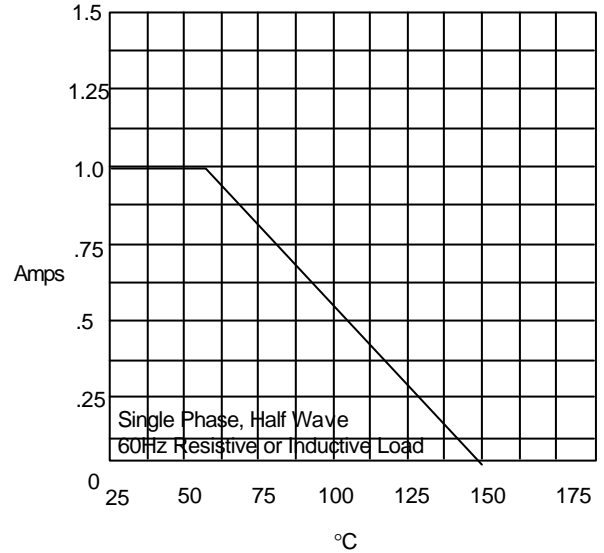


Figure 1
Typical Forward Characteristics



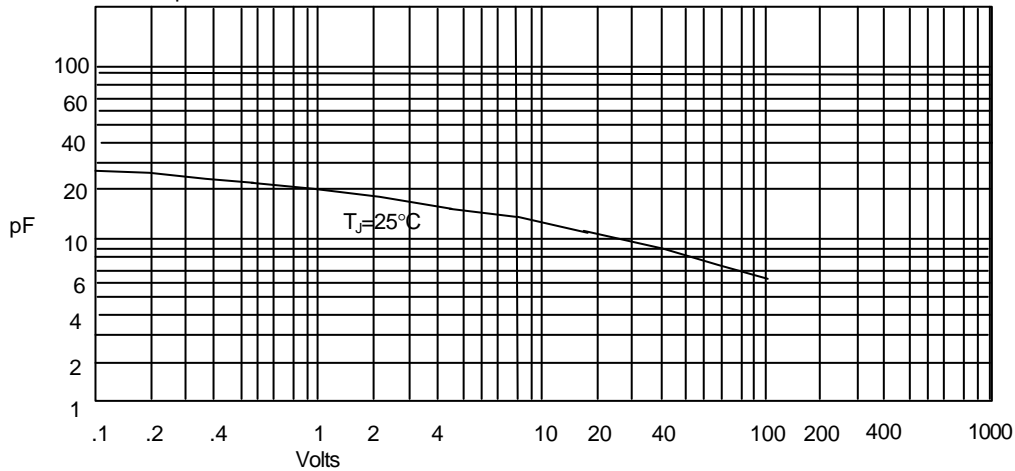
Instantaneous Forward Current - Amperes versus
Instantaneous Forward Voltage - Volts

Figure 2
Forward Derating Curve



Average Forward Rectified Current - Amperes versus
Ambient Temperature - °C

Figure 3
Junction Capacitance

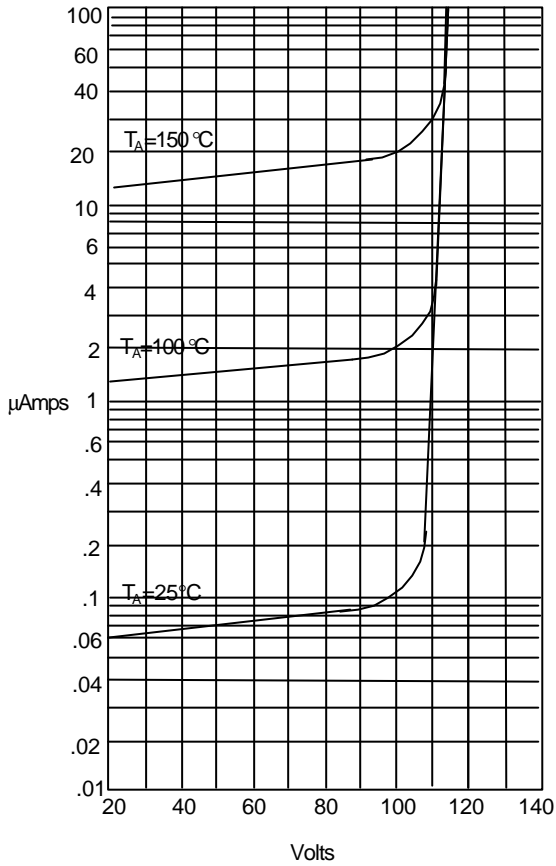


Junction Capacitance - pF versus
Reverse Voltage - Volts



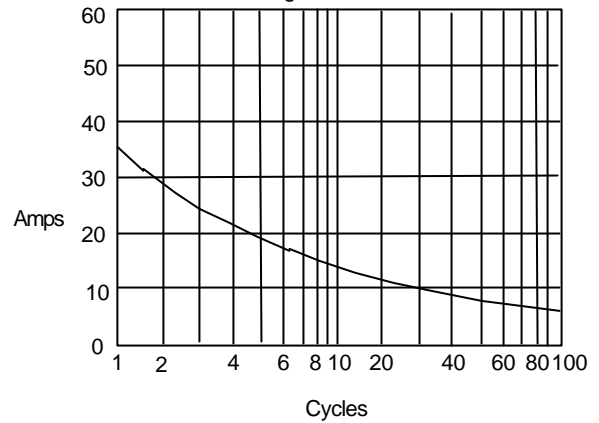
MUR105 thru MUR110

Figure 4
Typical Reverse Characteristics



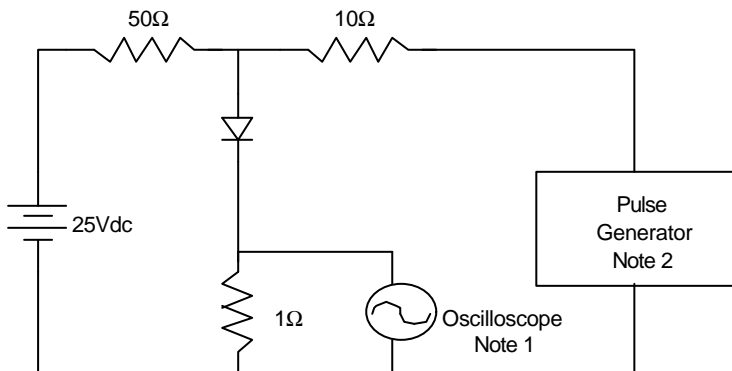
Instantaneous Reverse Leakage Current - MicroAmperes versus

Figure 5
Peak Forward Surge Current



Peak Forward Surge Current - Amperes versus Number Of Cycles At 60Hz - Cycles

Figure 6
Reverse Recovery Time Characteristic And Test Circuit Diagram



- Notes:
1. Rise Time = 7ns max.
Input impedance = 1 megohm, 22pF
 2. Rise Time = 10ns max.
Source impedance = 50 ohms
 3. Resistors are non-inductive

